

OVERLAND FLOW ON RANGELAND WATERSHEDS*

D. A. Woolhiser, C. L. Hanson and A. R. Kuhlman†

ABSTRACT

The kinematic cascade was used as a mathematical model to describe overland and open-channel flow for small (0.81-hectare) rangeland watersheds. The friction relationship for overland flow was assumed to be of the Darcy-Weisbach form, with initially laminar flow becoming turbulent at a transitional Reynolds number of 300. For laminar flow, the Darcy-Weisbach friction factor f can be expressed as[‡]

$$f = k/N_R$$

where k is a parameter and N_R is the Reynolds number.

Optimum values of the parameter k were obtained by a univariate optimization procedure for four heavily grazed watersheds and four lightly grazed watersheds for a single storm. Although these watersheds showed substantial differences in vegetal composition and cover in weight of vegetation per unit area, the roughness parameters were not significantly different. The average of the eight optimized parameters was used in the kinematic-cascade model to predict hydrographs for four moderately grazed watersheds with very good results.

The kinematic-cascade model appears to be satisfactory for describing overland flow on small rangeland watersheds. The roughness parameter k in the laminar friction relationship is approximately 7,000 for native short-grass prairie rangelands in western South Dakota, U.S.A.

INTRODUCTION

The shallow-water equations, or an approximation to them called the kinematic-wave equation, may be used as physically-based, deterministic models of overland and open-channel flow. A functional relationship between the friction slope, S_f , the mean velocity, u , the hydraulic radius, R , and some measure of the surface roughness characteristics is an essential element in the shallow-water equations and serves as the defining relationship

* Contribution from the Northern Plains Branch, Soil and Water Conservation Research Division, Agricultural Research Service, USDA, in cooperation with the Colorado and South Dakota Agricultural Experiment Stations.

† Research Hydraulic Engineer, USDA, Fort Collins, Colorado; Agricultural Engineer, USDA, Rapid City, South Dakota; and Botanist, USDA, Newell, South Dakota.

between u and R in the kinematic-wave approximation. The Manning or Chézy equations are frequently used as the friction relationship for open-channel flow and appear to be satisfactory when empirical data are available to assist in estimating the roughness coefficients.

Experimental evidence indicates that overland flow is initially laminar and may become turbulent under certain circumstances (Morgali, 1970; Schaake, 1965; Das and Huggins, 1970; Woo and Brater, 1962; Yu and McNown, 1964).

If the flow is laminar, the parameter k in the friction relationship

$$f = k/N_R \quad (1)$$

must be estimated, where f is the friction factor in the Darcy-Weisbach formulation and N_R is the Reynolds number. If the flow is initially laminar but becomes turbulent at higher flow rates, at least two parameters must be estimated: k as in the laminar case, and either a transitional Reynolds number or a Chézy C or Manning's n . For a very smooth surface, k can be derived theoretically and has a lower limit of 24. In an analysis of experimental data obtained by Izzard (1943), Morgali found that k varied from 14 to 35 for smooth asphalt, 20 to 65 for a crushed-slate surface and from 5,000 to 14,000 for turf surfaces. No objective technique has been developed to estimate the transitional Reynolds number. Morgali (1970) indicates the laminar-to-turbulent transition occurring at a Reynolds number of approximately 100 for a turf plane. Yu and McNown (1964) found a transitional Reynolds number between 200 to 1,000 for flow on a concrete surface. Chow (1959) suggests a range of from 500 to 2,000 for open-channel flow.

It is quite obvious that severe approximations are inherent in the use of the shallow-water equations or the kinematic-wave equations as a model of overland flow over rough planes or on natural watersheds. If the parameters of the friction relationship are estimated by minimizing some measure of the error between observed and computed hydrographs, the intrinsic errors introduced by the original approximations, the geometrical simplification of the natural system, and the estimates of rainfall input and infiltration, all become lumped into the friction parameters.

Consider a sequence of runoff events from two adjacent, apparently identical watersheds, and denote the estimated parameters as k_1 , k_2 , and C_1 , C_2 . Because of the simplifications inherent in the model and natural variability, these parameters will be random variables. The question of how variable such parameters might be is extremely important if the hydraulic approach is to be useful for natural watersheds.

The objective of the research reported herein was to obtain estimates of roughness parameters for overland flow on small, rather simple watersheds and to investigate the variability of these empirically determined quantities.

THE MATHEMATICAL MODEL

The kinematic-wave equation has been used to describe overland and open-channel flow in the subsequent analysis. The mathematical properties of the kinematic wave have been considered in general by Lighthill and Whitham (1955) and for particular application in hydrology by Henderson and Wooding (1964), Wooding (1965), and Kibler and Woolhiser (1970).

The continuity equation is

$$\frac{\partial A}{\partial t} + \frac{\partial Q}{\partial x} = q(x,t) \quad (2)$$

where A is the cross-sectional area, Q is the volumetric rate of discharge, $q(x,t)$ is the volumetric lateral inflow rate per unit length of channel, and x and t are the space and time coordinates.

The friction relationship is written in the Darcy-Weisbach form because much of the experimental analysis has used this form

$$u = \sqrt{[(8g/f)S_0R]} \quad (3)$$

where u is the local mean velocity in the x direction, R is the hydraulic radius, S_0 is the slope of the channel or plane, g is the acceleration of gravity, and f is the friction factor. For flow over a plane or in wide, rectangular channels, A and R in equations (2) and (3) can be replaced by the depth, h , for a section of unit width.

In the laminar range, the friction factor is given by

$$f = k/N_R \quad (4)$$

For turbulent flow, using the Chézy equation, f is found from

$$f = 8g/C^2 \quad (5)$$

In this study it was assumed that flow in channels was always turbulent, and that the Chézy relationship was valid. Flow over planes was assumed to begin as laminar flow until it reached a critical Reynolds number, whereupon it became turbulent with a Chézy C chosen to maintain continuity in velocity.

Thus, at transition,

$$\frac{8gS_0h^2}{k\nu} = C\sqrt{(S_0h)} \quad (6)$$

where ν is the kinematic viscosity, and

$$h_T = \left(\frac{k\nu C}{8g\sqrt{S_0}} \right)^{2/3} \quad (7)$$

where h_T is the transition depth. For a given transition Reynolds number, C is a function of the parameter k

$$C = \sqrt{[(8g/k)N_R]} \quad (8)$$

Watershed geometry was modeled by representing the slopes as a series of discrete overland flow planes with the lowest plane discharging into a channel. This configuration with the kinematic-wave approximation describing the unsteady flow has been called a kinematic cascade by Kibler and Woolhiser (1970). An n -plane cascade receiving lateral inflow and discharging into a channel segment is shown in Figure 1.

For a plane, equation (3) may be written as

$$u = \alpha h^{N-1} \quad (9)$$

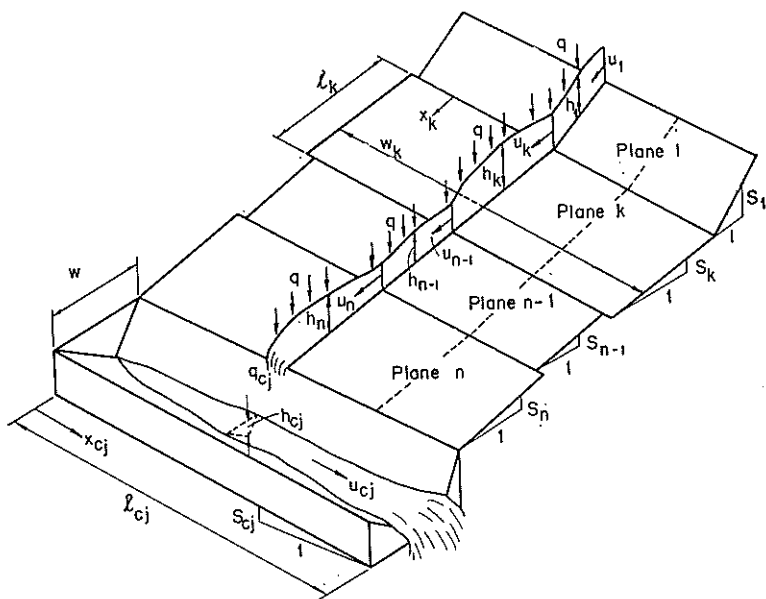

FIG. 1 — Cascade of n planes contributing lateral inflow to a channel.

which, when substituted into equation (2), gives

$$\frac{\partial h}{\partial t} + \frac{\partial \alpha h^N}{\partial x} = q(x,t) \quad (10)$$

Equation (10) was solved numerically using a second-order, finite-difference method known as the single-step Lax-Wendroff method (see Kibler and Woolhiser, 1970).

$$\begin{aligned} h_j^{i+1} = & h_j^i - \Delta t \left[\frac{(\alpha h^N)_{j+1}^i - (\alpha h^N)_{j-1}^i}{2\Delta x} - \frac{1}{2}(q_{j+1}^i - q_{j-1}^i) \right] \\ & + \frac{1}{2}\Delta t^2 \left[\frac{(N\alpha h^{N-1})_{j+1}^i + (N\alpha h^{N-1})_j^i}{2\Delta x} \right] \left[\frac{(\alpha h^N)_{j+1}^i - (\alpha h^N)_j^i}{\Delta x} - \frac{1}{2}(q_{j+1}^i + q_j^i) \right] \\ & - \left[\frac{(N\alpha h^{N-1})_j^i + (N\alpha h^{N-1})_{j-1}^i}{2\Delta x} \right] \left[\frac{(\alpha h^N)_j^i - (\alpha h^N)_{j-1}^i}{\Delta x} - \frac{1}{2}(q_j^i + q_{j-1}^i) + \right. \\ & \left. + \frac{q_j^{i+1} - q_j^i}{\Delta t} \right] \quad (11) \end{aligned}$$

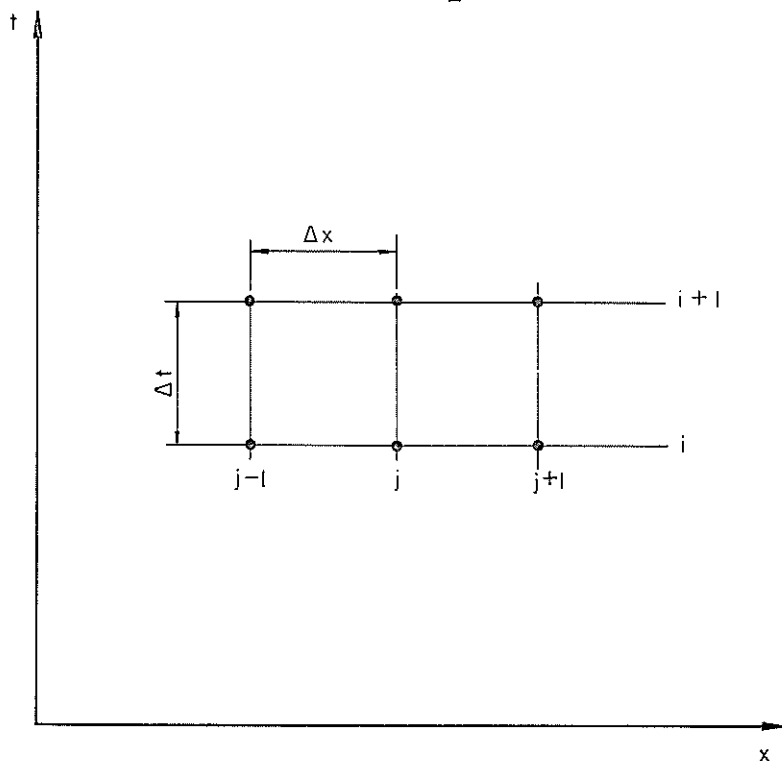

FIG. 2 — Notation for finite-difference schemes.

where the finite-difference notation is shown in Figure 2. The notation $(\alpha h^N)_{j+1}^i$ indicates that the quantities are evaluated at $i\Delta t, (j+1)\Delta x$.

The linear stability criterion for this explicit scheme is:

$$\frac{\Delta t}{\Delta x} \leq \frac{1}{N\alpha h^{N-1}} \quad (12)$$

An upstream differencing scheme was used at the downstream boundary of each plane. The discharge from plane $n-1$ at time t establishes the upstream boundary condition for plane n at time t . For example, the discharge per unit width at the upstream boundary of plane n is

$$Q_u^n(t) = Q_L^{n-1}(t) \frac{W(n-1)}{W(n)} \quad (13)$$

where $Q_u^n(t)$ is the discharge per unit width at the upper boundary of plane n ; the subscript L denotes the lower boundary and $W(\)$ is the width of the plane.

During calculations each depth h_j^{i+1} was checked to see if it was in the laminar or turbulent range, and the appropriate values of α and N were used in equation (11).

Channels were assumed to be triangular or trapezoidal in cross-section. A finite-difference equation analogous to equation (11) was used for channel computations. Discharges from contributing channels were added at channel junctions.

THE EXPERIMENTAL WATERSHEDS

Twelve small watersheds of approximately 2 acres (0.81 hectares) each were chosen for this analysis. These watersheds are located on the Range Field Station (Figure 3), Cottonwood, South Dakota, U.S.A. A substation of the South Dakota Agricultural Experiment Station, it is at an elevation of 2,414 feet (736 m) and is located at latitude $43^\circ 58'$ and longitude $101^\circ 52'$.

The mean annual precipitation at the Field Station headquarters for the period 1910 through 1967 was 15.22 inches (387 mm) and has ranged from 7.13 inches (181 mm) in 1936 to 27.62 inches (703 mm) in 1915 (Spuhler *et al.*, 1968). During the growing season, thunderstorms are associated with most of the precipitation, and therefore there is a wide range in amounts and intensities of rain. June is the month of highest precipitation with an average of 2.99 inches (76 mm). The driest is December when the average precipitation is 0.35 inch (9 mm).

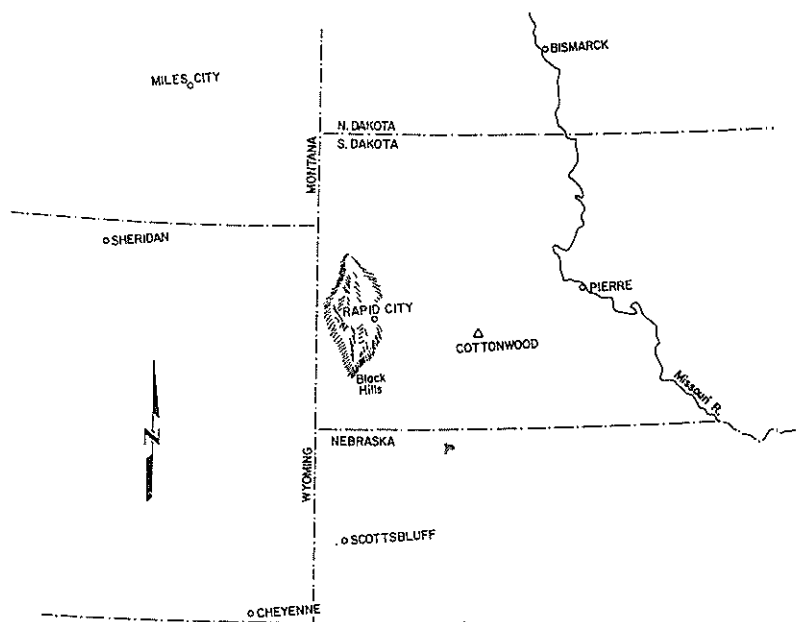

FIG. 3 — Location map, Cottonwood Range Field Station.

The mean monthly temperature at the Field Station headquarters varies from a high of 74.7°F in July to a low of 19.1°F in January. The mean annual temperature is 46.7°F.

The Chestnut soils of the watersheds have been classified in the Opal-Samsil association (Westin *et al.*, 1967). In general, the soils are dark brown, moderately deep, slowly permeable, heavy clays derived from the Pierre formation.

Watershed study areas in each of three differentially grazed pastures were established in 1962. Confining dikes were constructed on four 2-acre (0.81-hectare) contiguous watersheds (Figure 4) on each of the three pastures. The slope averages 7.9%, 7.6% and 7.8% respectively, for the heavy-, moderate-, and light-use watersheds. Each set of watersheds has a northeast aspect. Two-foot H-flumes and FW-1 water-stage recorders measure runoff. Four recording rain gages measure the precipitation on each set of watersheds.

The pastures had been grazed heavily, moderately, and lightly since 1942. Fixed stocking rates were used through 1951. Since 1952 "put-and-take animals" have been used to assure forage utilization to over 55% for the heavily used pasture, 35% to 55% for the moderately used pasture, and less than 35% for the lightly used pasture (Lewis *et al.*, 1956).

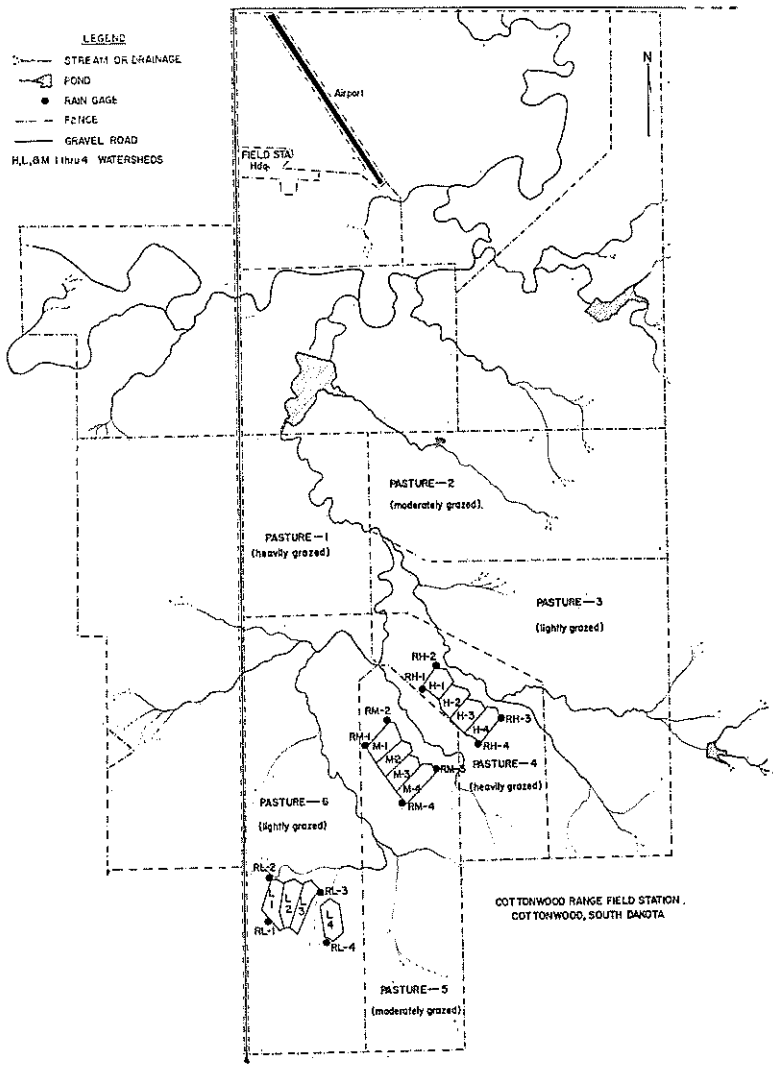

FIG. 4 — Location of Cottonwood watersheds. (Scale, 1:28,250.)

Before the inception of the grazing-intensity study, this mixed prairie area was dominated largely by midgrasses with an understorey of short grasses and sedges (Lewis *et al.*, 1956).

In the last 26 years under three intensities of controlled grazing, the midgrasses have decreased on the moderate- and heavy-use watersheds, leaving the short grasses and sedges. Japanese

brome (*Bromus japonicus*), recently invaded the area, becoming most prevalent in the light-use watersheds.

Vegetation samples were harvested in late July from transects within each watershed. Samples were taken at ground level to include remaining litter. The vegetation on the watersheds is primarily short grasses and midgrasses. The short grasses and sedges include buffalograss (*Buchloe dactyloides*),* blue grama (*Bouteloua gracilis*), threadleaf sedge (*Carex filifolia*), needleleaf sedge (*Carex eleocharis*), and Sandberg's bluegrass (*Poa secunda*). The midgrasses include western wheatgrass (*Agropyron smithii*), needle-and-thread (*Stipa comata*), green needlegrass (*Stipa viridula*), side-oats grama (*Bouteloua curtipendula*), and little blue-stem (*Andropogon scoparius*).

Mean oven-dry weights of grasses and sedges were 819, 364 and 404 pounds per acre (918, 408, and 453 kg/ha) from the light-, moderate- and heavy-use watersheds, respectively (Table 1). The corresponding litter weights were 2,082, 1,325 and 1,008 pounds per acre (2,334, 1,485 and 1,130 kg/ha).

TABLE 1—Vegetal weight (pounds per acre, oven-dry weight; kg/ha in brackets) and percentage composition of basal cover, Cottonwood Range Field Station, 1967. Values are the mean of four watersheds.

	Vegetal weight			Composition of basal cover (%)				
	Grasses & sedges	Forbs	Litter	Grasses & sedges	Forbs	Litter	Rock	Bare
Light-use watersheds	819 (918)	391 (438)	2082 (2334)	58	3	34	1	4
Moderate-use watersheds	364 (408)	183 (205)	1325 (1485)	65	4	26	0	5
Heavy-use watersheds	404 (453)	60 (67)	1008 (1130)	68	6	23	1	2

Table 1 shows that the grasses and sedges make up 58% of the basal cover on the light-use watersheds and 68% on the heavy. About one-third of the basal cover on the light-use watersheds and one-fourth of the basal cover on the other watersheds was litter. Forbs, rocks and bare soil accounted for less than 10% of the cover on all of the watersheds.

The effects of grazing intensity are also reflected in the species of vegetation harvested from the various watersheds. Short grasses

* Nomenclature follows Hitchcock (1950).

and sedges predominated in the heavy-use watersheds, while western wheatgrass was important in the mixture of grasses on the light-use watersheds. The long-time effects of grazing intensity reflected a limited amount of midgrasses, such as western wheatgrass, among the predominantly short grasses on the moderate-use areas.

Very little variation in sample weights between the four replications on any of the treatments was shown for either the clipping areas or the point line transects.

ANALYSIS OF DATA

To eliminate as much as possible the interaction effects of infiltration estimation upon the determination of watershed-roughness parameters, a storm was chosen wherein rain fell for a total of nearly 11 hours. An intense burst of rainfall occurred about 9.5 hours after the beginning of rainfall and resulted in an easily identified peak rate of runoff. Runoff occurred at all watersheds for at least 9 hours. Considering the nature of the soils at these watersheds, one can assume a constant infiltration rate for the last hour of the storm. Infiltration rates were computed by assuming that surface storage at the beginning of the intense portion of rainfall was the same as the storage remaining at the same flow rate during the recession. Infiltration during this interval was then the difference between rainfall and runoff. The infiltration rates calculated are shown in Table 2.

TABLE 2—Constant infiltration rates during last hour of storm, 15 July 1967. Values are in inches per hour; mm/min in brackets.)

Treatment	Replication				Average
	1	2	3	4	
Light	0.105 (0.0445)	0.109 (0.0462)	0.114 (0.0483)	0.122 (0.0517)	0.113 (0.0480)
Medium	0.080 (0.0338)	0.094 (0.0398)	0.062 (0.0268)	0.052 (0.022)	0.072 (0.0305)
Heavy	0.101 (0.0428)	0.067 (0.0284)	0.079 (0.0335)	0.075 (0.0318)	0.081 (0.0343)

Lateral inflow rates, $q(x,t)$ as shown in equation (2), were obtained as step functions in time by subtracting the infiltration rates in Table 2 from rainfall rates obtained from recording rain

gages. These rates became negative when infiltration rates were greater than runoff rates.

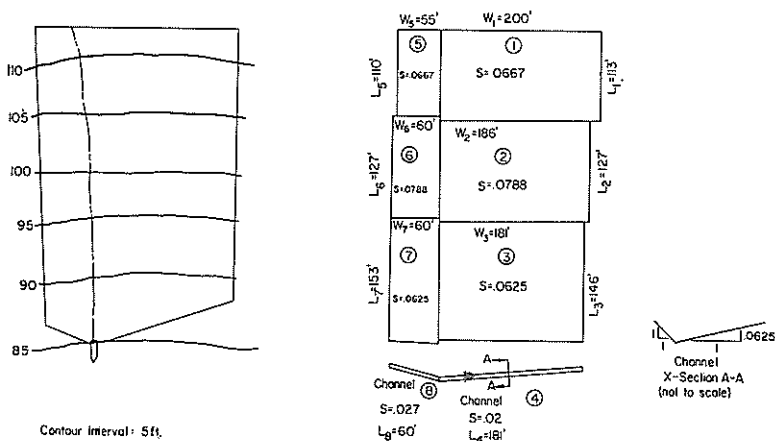

FIG. 5 — Topographic map and cascade representation of Watershed H-3, Cottonwood, South Dakota. (Scale, 1:2850.)

Watershed geometry was approximated by a series of planes and channels as shown in the example of Figure 5. First the watershed was divided into areas contributing to individual channels by drawing a stream line upstream from the measuring flume to the watershed divide. These contributing areas were then subdivided into rectangular planes to account for slope or width variations. The collecting channels at the lower boundary of the watershed were constructed by building a low dike on the watershed surface. The cross-section of these channels was approximated by a triangular section having 1:1 side slopes on the dike side and the natural watershed slope on the other side.

Runoff was occurring from all watersheds at the beginning of the higher-intensity rainfall period that was used in this study. A steady-state initial condition was assumed for all planes, where the steady-state flow rate was equal to the observed discharge rate at the beginning of the computed event. The channels were assumed to be initially dry.

The parameter k was given an initial value estimated from previous studies. When the computations were completed for an event with the trial value of k , the computed and observed discharges were reduced to rates at uniform 3-minute increments. The sum of squares of deviations was then computed, and a

univariate search technique was used to find the minimum value of the objective function.

Thus the objective function was

$$F = \sum_{i=1}^n (Q_{\text{comp}} - Q_{\text{obs}})^2$$

The search technique used varied k in the direction of decreasing F until the intermediate value of three successive F computations was less than the other two. A parabola was then fitted through the three points and the minimum value was computed by setting the derivative equal to zero. The k so obtained was assumed to be the optimal value. This method cannot guarantee optimality, but from the shape of the objective functions the k values should be within 10% of the optimal value. Because of the single-peaked

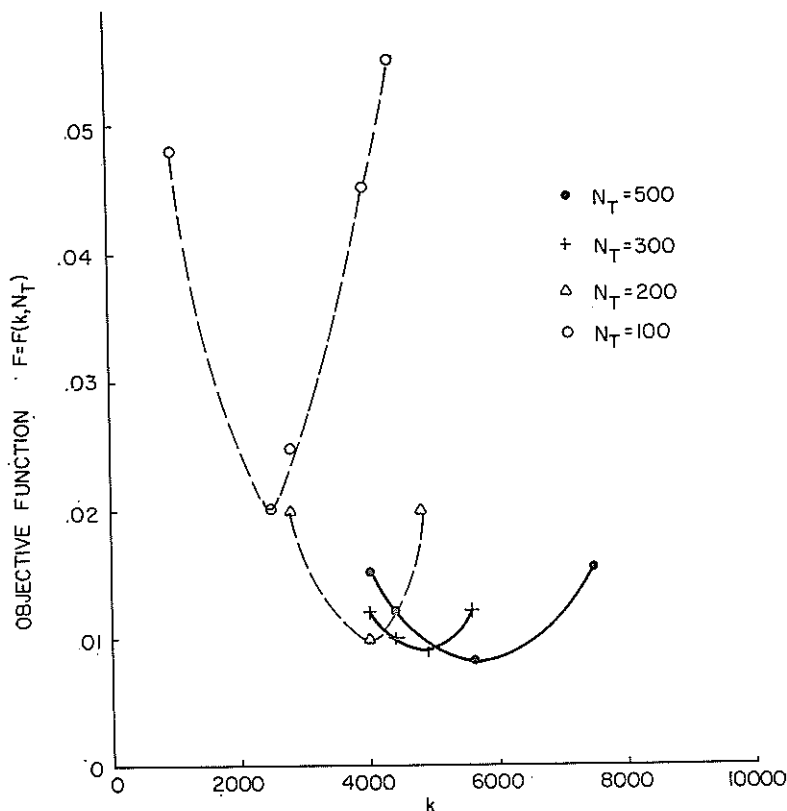

FIG. 6 — Objective function, Watershed H-1.

shape of the hydrographs, it is extremely unlikely that local minima would exist.

As the problem has been formulated, the objective function depends upon the parameters k and N_T or C , where N_T is the transitional Reynolds number. To obtain a single point on the objective function, the complete hydrograph must be computed. Based upon the observations of previous investigations and an exploration of the bivariate response surface for watersheds H-1 and H-4, a transitional Reynolds number of 300 was used in all calculations. The behaviour of the objective function is shown in Figure 6.

Optimum k values for a transitional Reynolds number of 300 were computed for the four heavily grazed watersheds and the four lightly grazed watersheds. The parameter values obtained are shown in Table 3. The best and worst fits obtained are shown in Figure 7. A t -test indicated that there is no reason to believe that the mean k for the lightly grazed watersheds is different from the mean for the heavily grazed watersheds. Because these watersheds have the greatest difference in vegetal cover (see Table 1), it can be inferred that intensity of grazing has no significant effect on hydraulic parameters.

TABLE 3—Optimized parameters for $N_T=300$. Mean k for lightly grazed watersheds 6,029; standard deviation 2,165. Mean k for heavily grazed watersheds 7,487; standard deviation 3,690.

	<i>Heavily grazed watersheds</i>				<i>Lightly grazed watersheds</i>			
	<i>L-1</i>	<i>L-2</i>	<i>L-3</i>	<i>L-4</i>	<i>H-1</i>	<i>H-2</i>	<i>H-3</i>	<i>H-4</i>
<i>k</i>	3932	8919	6495	4769	4875	3761	10518	10793
<i>C</i>	4.43	2.94	3.45	4.03	3.98	4.53	2.71	2.68
<i>F</i>	0.080	0.034	0.068	0.067	0.009	0.008	0.018	0.014

The minimum k value of 3,760 and the maximum of 10,700 are both less than the respective extremes for turf calculated by Morgali (1970). However, it is quite likely that there are real differences between the turf used by Izzard and the short-grass prairie vegetation found on the Cottonwood watersheds.

The f versus N_R relationships for this study are shown along with Morgali's envelope curves in Figure 8. The range in k is somewhat smaller than was obtained by Morgali, who analyzed repeated

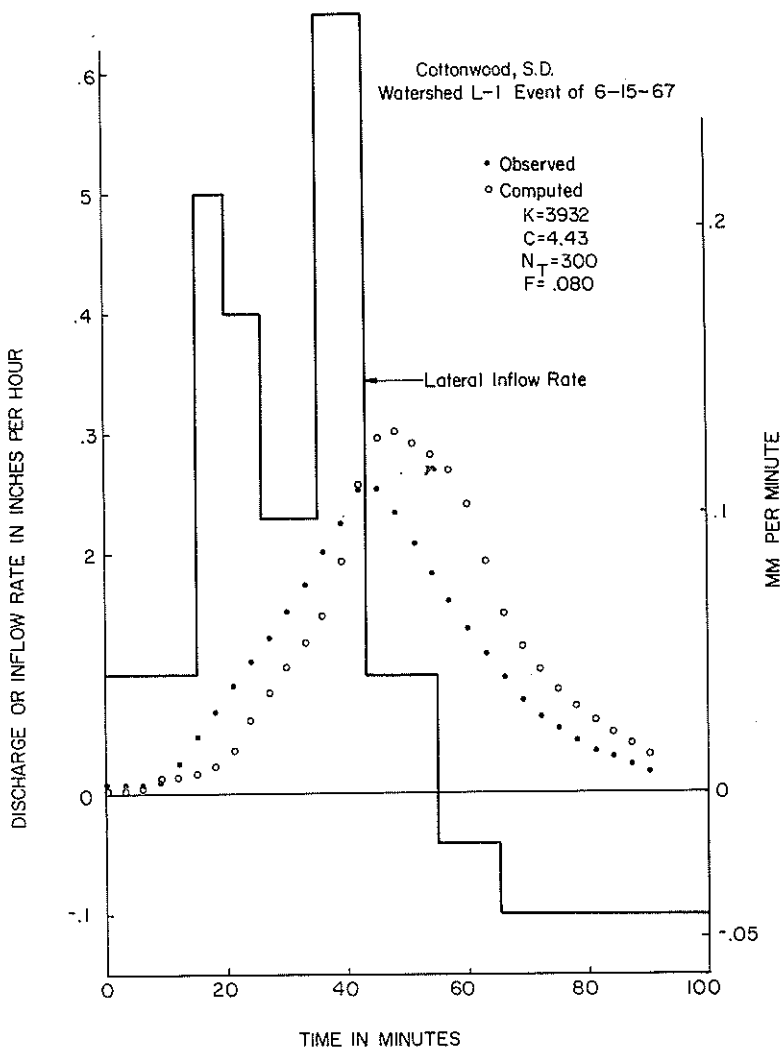

FIG. 7(a) — Worst-fitting optimized hydrograph.

experiments on the same material but with varying slopes, length and rainfall intensity.

When a fixed transitional Reynolds number is used, the Chézy C varies with k according to equation (8). At a steady state condition with a uniform lateral inflow rate of 0.25 inches per hour (0.106 mm/h), a Reynolds number of 300 would be reached only

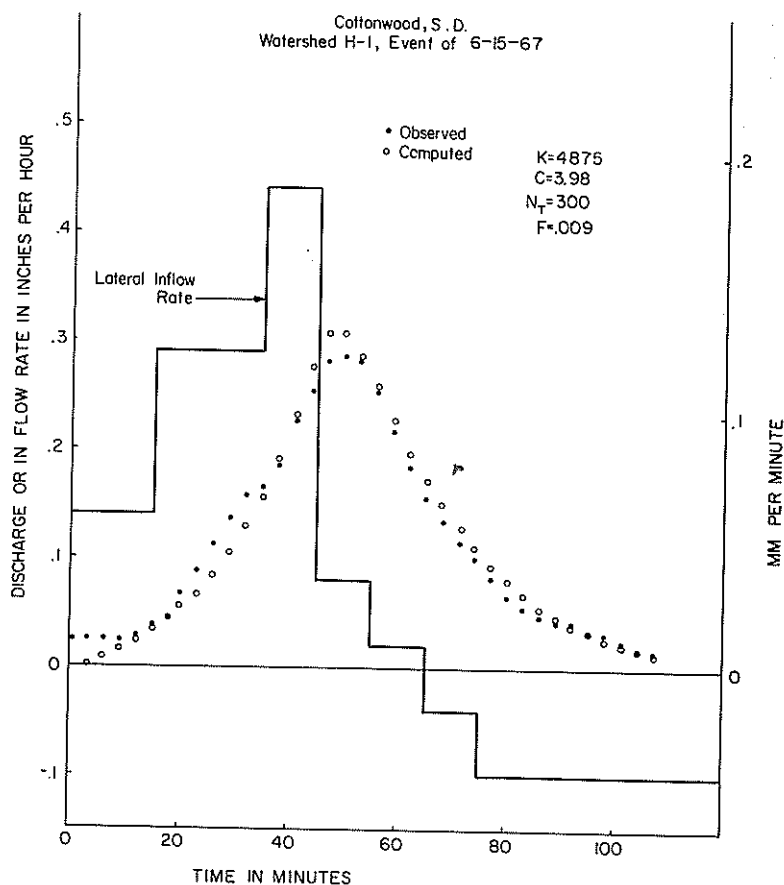

FIG. 7(b) — Best-fitting optimized hydrograph.

after an overland flow distance of 518 feet (170 m). Where there is appreciable convergence, this distance decreases.

The Cottonwood watersheds vary from approximately 400 feet to 600 feet (131 to 197 m) in length, with the lightly grazed watersheds being the longest and the heavily grazed watersheds the shortest. Apparently turbulent overland flow either did not occur or was present only for a very limited time on the lower planes of the cascade. In the optimization process, as the transitional Reynolds number increased, the overland flow became more dependent upon the laminar roughness parameter k until at high values of N_T no transition would occur and the overland flow

hydrograph would depend only upon k . The friction factor for the channels was assumed to be equal to that for turbulent overland flow so as N_T increased, the channel friction factor decreased and the channels began to influence the outflow hydrograph. It was noted, however, that in most cases the channel did very little more than lag the overland flow hydrograph by approximately two or three minutes.

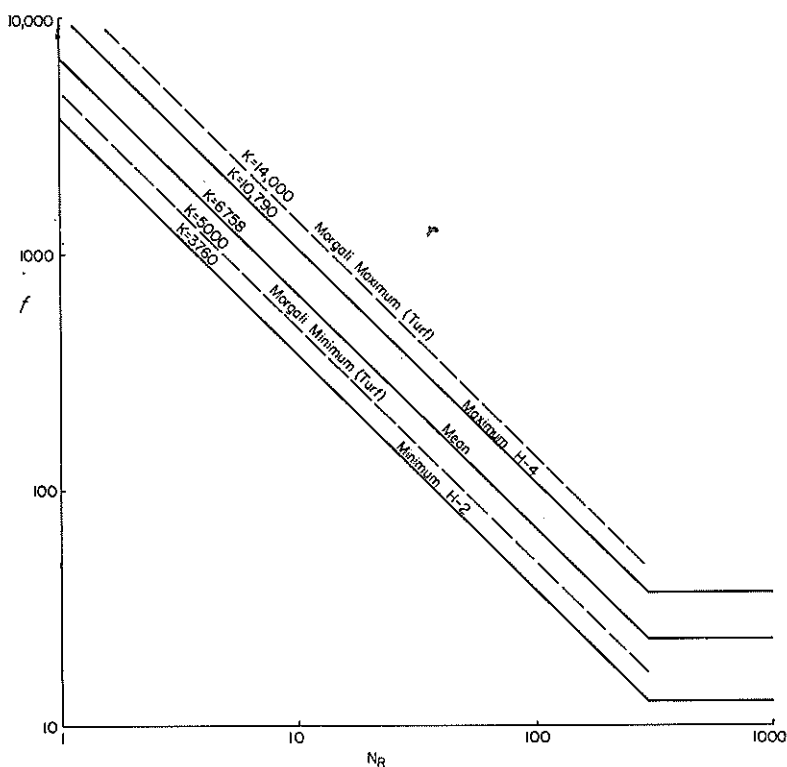

FIG. 8 — Darcy-Weisbach f versus Reynolds number.

As a test of the predictive capability of the mathematical model, hydrographs were computed for the four moderately grazed watersheds for the same storm with the parameter k set equal to the mean of the optimized k values for the lightly and heavily grazed watersheds. The best-fitting and the worst-fitting hydrographs are shown in Figure 9 and a tabulation of objective function values, F , and a comparison of observed and computed peak rates are shown in Table 4.

TABLE 4—Comparison of observed and computed hydrographs.

Watershed	Observed rate in./h (mm/min)	Computed rate in./h (mm/min)	% Error	F
M-1	0.252 (0.107)	0.261 (0.110)	+3.6	0.07
M-2	0.215 (0.091)	0.206 (0.087)	-4.2	0.012
M-3	0.293 (0.124)	0.317 (0.134)	+7.6	0.059
M-4	0.302 (0.128)	0.285 (0.121)	-5.6	0.025

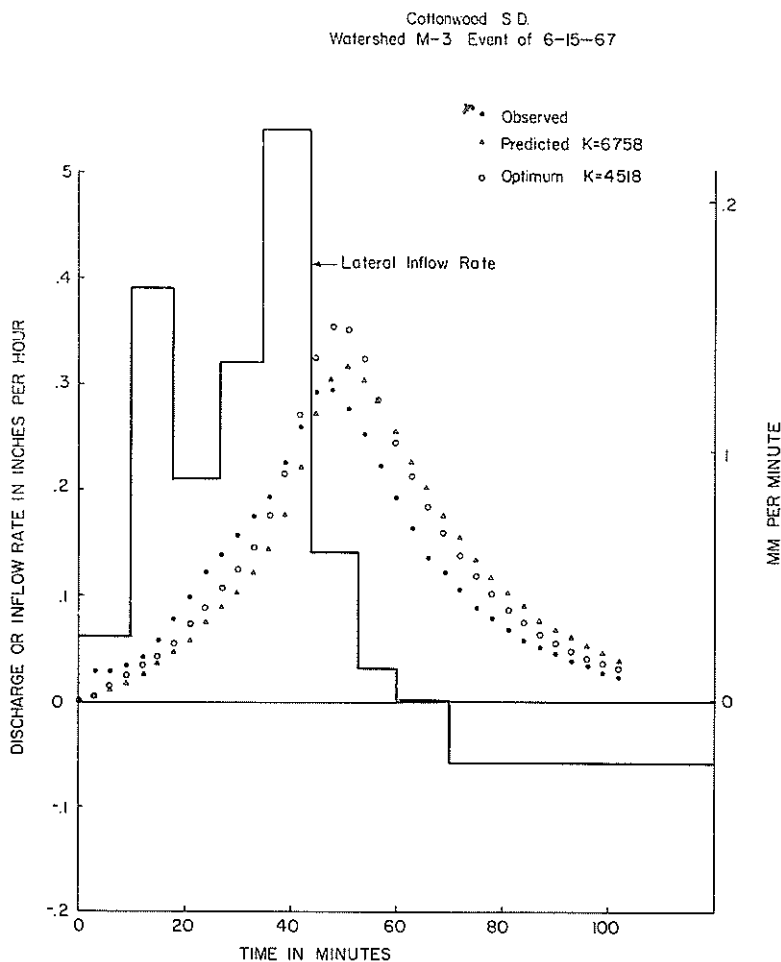

FIG. 9(a) — Worst-fitting predicted hydrograph.

Cottonwood, S.D.
Watershed M-2 Event of 6-15-67

- Observed
- △ Predicted

k=6758

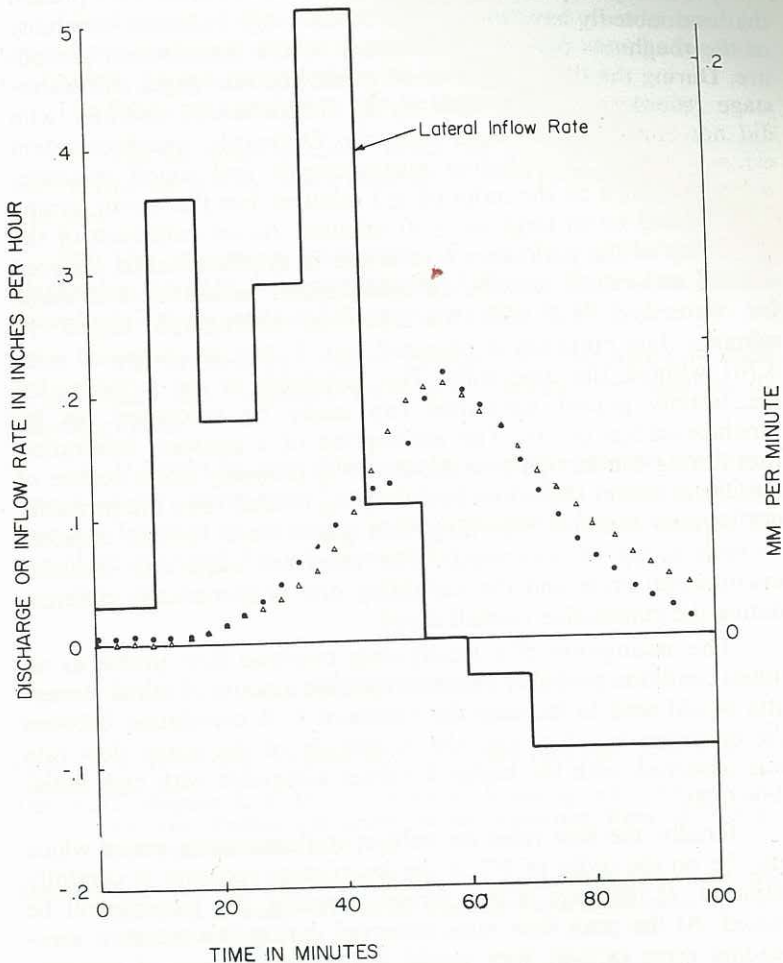

FIG. 9(b) — Best-fitting predicted hydrograph.

The observed and computed hydrographs agree very well. Because these watersheds were not used to estimate the roughness parameters, this prediction suggests that the kinematic cascade is an acceptable model for overland flow on watersheds of this

size, and that the roughness parameters might be used in other areas with similar topography and vegetal characteristics.

DISCUSSION OF SOURCES OF ERROR

As in any empirical study, several sources of error were present that undoubtedly have some effect on the magnitude and variability of the roughness parameters obtained by the optimization procedure. During the time of the runoff event, the rain gages and water-stage recorders were serviced by an inexperienced operator who did not annotate the charts properly. Ordinarily, synchronization errors between precipitation measurements and runoff measurements would be on the order of ± 5 minutes. For this storm, timing errors could be as large as ± 10 minutes. As an indication of the sensitivity of the parameter k to errors in synchronization between rainfall and runoff records, an optimization calculation was made for watershed H-2 with the observed hydrograph lagged 10 minutes. The optimum k obtained was 11,660 as compared with 3,761 without the time shift. The variability in the k values for the heavily grazed watershed can easily be accounted for by synchronization errors. The assumption of a constant infiltration rate during the last part of the storm is probably not a source of significant error. The errors in estimating rainfall rates are probably not serious because recording rain gages were located adjacent to each group of watersheds. The rates are subject to ordinary instrumental error and the variability due to numerically differentiating the cumulative rainfall curve.

The assumption of a steady-state overland flow profile as an initial condition probably overestimates the amount of initial storage and would tend to increase the optimum k . A correlation between the optimum k values and the magnitude of the initial flow rate was observed, with the higher k values associated with high initial flow rates.

Finally, the flow rates are subject to flume-rating errors which may be on the order of 3% if the water-stage recorder is carefully adjusted. If the gage is not zeroed properly, the records will be biased. At the peak flow rates observed during this storm, a zero-reading error of 0.01 foot would introduce an error of approximately 4%.

SUMMARY AND CONCLUSIONS

The kinematic cascade was used as a mathematical model to describe overland and open-channel flow for small rangeland watersheds. Optimum roughness parameters were computed for

four heavily grazed watersheds and four lightly grazed watersheds for a single storm. Although these watersheds showed substantial differences in vegetal composition and cover in weight of vegetation per unit area, the roughness parameters for the lightly grazed watersheds were not significantly greater than for the heavily grazed watersheds.

The average of the eight roughness parameters was used in the kinematic-cascade model to predict runoff hydrographs for four moderately grazed watersheds with very good results.

The following conclusion can be drawn from this study:

(1) The kinematic-cascade model can accurately describe the outflow hydrograph for small watersheds with predominantly overland flow.

(2) The roughness parameter, k , in the laminar friction relationship $f = k/N_R$ is approximately 7,000 for short-grass prairie watersheds if the transitional Reynolds number is 300.

(3) The friction parameters obtained by the methods used in this study are consistent with those obtained by analysis of laboratory data.

(4) It would be desirable to make a similar analysis for other storms where timing errors would be small. The response of the objective function to variations in the transitional Reynolds number should be explored for all watersheds.

REFERENCES

- Chow, V. T. 1959: *Open Channel Hydraulics*. McGraw-Hill, New York.
- Das, K. C.; Huggins, L. F. 1970: *Laboratory Modeling and Overland Flow Analysis*. Purdue University Water Resources Research Center, Lafayette, Indiana. 182 p.
- Henderson, F. M.; Wooding, R. A. 1964: Overland flow and groundwater flow from a steady rainfall of finite duration. *J. Geophys. Res.* 69 (8): 1531-1540.
- Hitchcock, A. S. 1950: Manual of the grasses of the United States. 2nd ed. (revised by Agnes Chase). *USDA Misc. Pub.* 200. 1051 p.
- Izzard, C. F. 1942-43: *Overland Flow Tests—Tabulated Hydrographs*. vol. 1-3. U.S. Bureau of Public Roads. (available from the Engineering Societies Library.)
- Kibler, D. F.; Woolhiser, D. A. 1970: The kinematic cascade as a hydrologic model. *Colorado State University Hydrology Paper No. 39*. 27 p.

- Lewis, J. K.; Van Dyne, G. M.; Albee, L. R.; Whetzal, F. W. 1956: Intensity of grazing — its effect on livestock and forage production. *South Dakota Agr. Exp. Sta. Bull. 459*. Brookings, S.D. 44 p.
- Lighthill, M. J.; Whitham, G. B. 1955: On kinematic waves. I. Flood movement in long rivers. *Proc. Roy. Soc. London (A) 229*: 281-316.
- Morgali, J. R. 1970: Laminar and turbulent overland flow. *Proc. ASCE 96 (HY2)*: 441-460.
- Schaake, J. C. 1965: Synthesis of the inlet hydrograph. *The Storm Drainage Research Project, Tech. Report No. 3*. John Hopkins University.
- Spuhler, W.; Lytle, W. F.; Moe, D. 1968: *Climatological Summary No. 14, Climatology of the U.S. No. 20-39*. (from U.S. Weather Bureau records.)
- Westin, F. C.; Puhr, L. F.; Buntley, G. J. 1967: Soils of South Dakota. *Soil Survey Series No. 3*. South Dakota Agr. Exp. Sta., Brookings, S.D. 32 p.
- Woo, D.-C.; Brater, E. F. 1962: Spatially varied flow from controlled rainfall. *Proc. ASCE 88 (HY6)*: 31-56.
- Wooding, R. A. 1965: A hydraulic model for the catchment-stream problem. I. Kinematic wave theory. *Journ. Hydrol. (Neth.) 3*: 254-267.
- Yu, Y. S.; McNown, J. S. 1964: Runoff from impervious surfaces. *Journ. Hydraulic Research 2 (1)*: 3-24.